

**CAUTION!**  
PLEASE KEEP POWER  
SWITCH ON BEFORE  
OPERATING THIS EQUIPMENT

# Refrigerator Freezer Installation and Operation Manual

Please read this manual completely before attempting to install or operate this equipment!

## SOLID DUAL TEMPERATURE

JRF-19      JRF-45

## SALAD TABLE (WITHOUT HOOD)

JBT-36      JBT-48  
JBT-60      JBT-72

## UNDERCOUNTER REFRIGERATOR / FREEZER

JUR-36      JUF-36  
JUR-48      JUF-48  
JUR-60      JUF-60  
JUR-72



## CONTENTS

	PAGE
1. THE INTRODUCTION.....	2
2. PART NAME AND FUNCTION	
UP-RIGHT .....	3-4
SALAD/UNDERCOUNTER .....	5-7
3. CAUTION .....	8-11
4. INSTALLATION AND OPERATION	
INSTALLATION NOTE .....	12
CLEANING .....	13
PRECAUTIONS .....	13
BEFORE REQUESTING SERVICE .....	14
5. WARRANTY .....	15-16

## AFTER SLAE SERVICE

### THE GUIDE OF AFTER SALE SERVICE

1. UNDER WARRANTY : The unit is not covered by this warranty...
  - Condenser is dirty
  - Incorrect Operation
  - The product isn't set correctly
  - Unauthorized service
2. OUT OF WARRANTY : We will repair the unit with pay by your needs.  
Please consult with the after sale service for details.

## CHECK THE FOLLOWS BEFORE REQUESTING SERVICE

- The unit has the data label, the serial number is in the left side of unit.
- Purchasing date
- Trouble (Detail)
- Your address, name, phone
- Your free time

## PART NAME AND FUNCTION

### TOP MOUNT (REFRIGERATOR, FREEZER)

#### 1、FRAMEWORK

- To maintain proper refrigeration performance, the condenser coil must be free of dust, dirt, and grease.
- This will require periodic cleaning. Condenser fins should be cleaned at least every three months (90 days) or as needed.

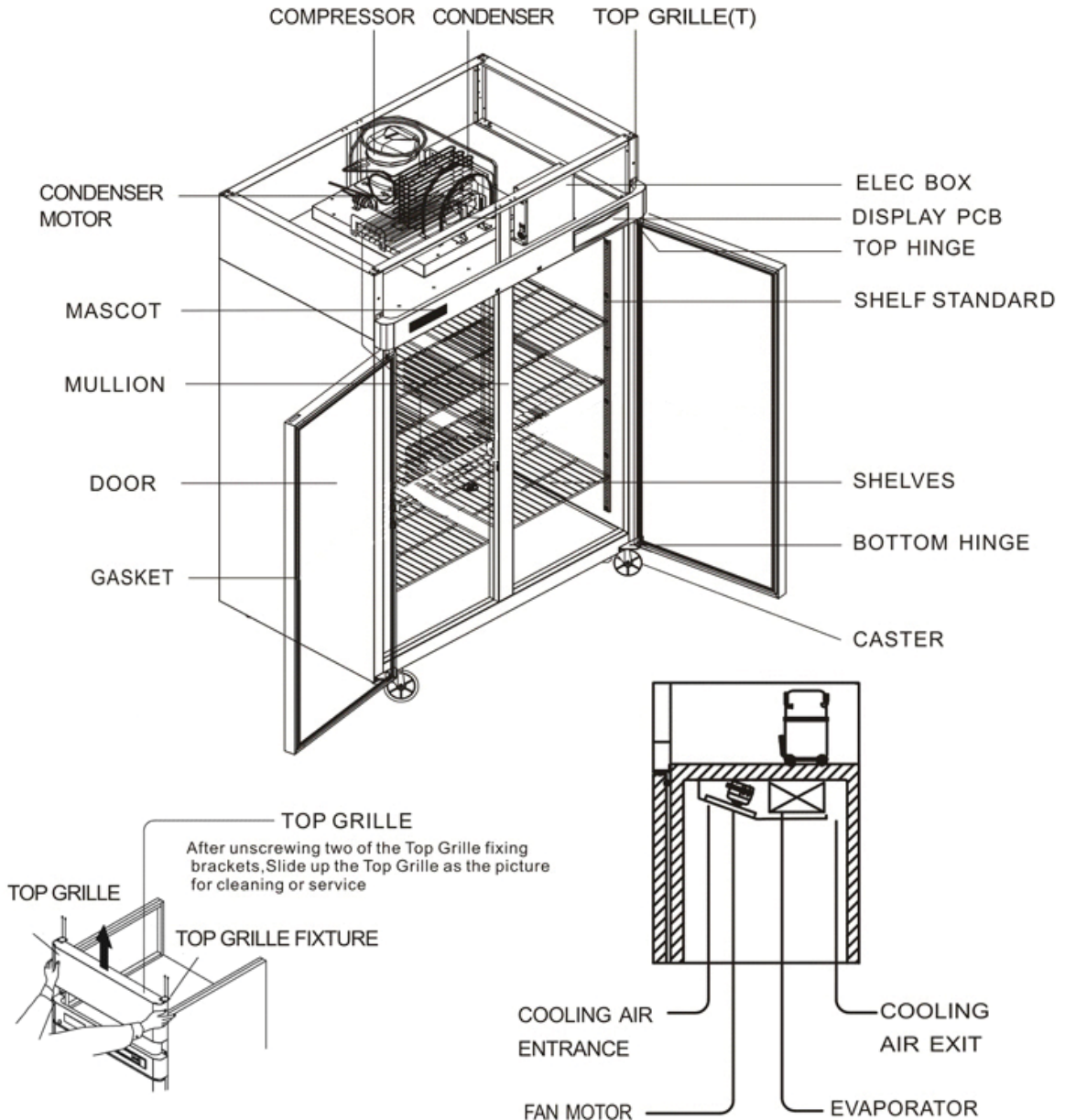

# DISPLAY PANEL OF DUAL TEMP

## BASIC OPERATION

1. Plug in and turn on the power switch located on the right side of top grille.  
The Display panel will be lighted and make a beep sound. The compressor will begin to run.
2. The default temperature setting is No. "4".
3. The compressor is automatically cycled by the electronic controller(PCB).
4. The Defrost cycle is automatically controlled by the PCB.
5. Set level toward "1" for higher temperature and "8" for lower temperatures.
6. Good Air Flow in freezer/refrigerator unit is critical.  
Be careful to load product so that it neither presses against the back wall, nor reaches within four inches from the evaporator compartment.

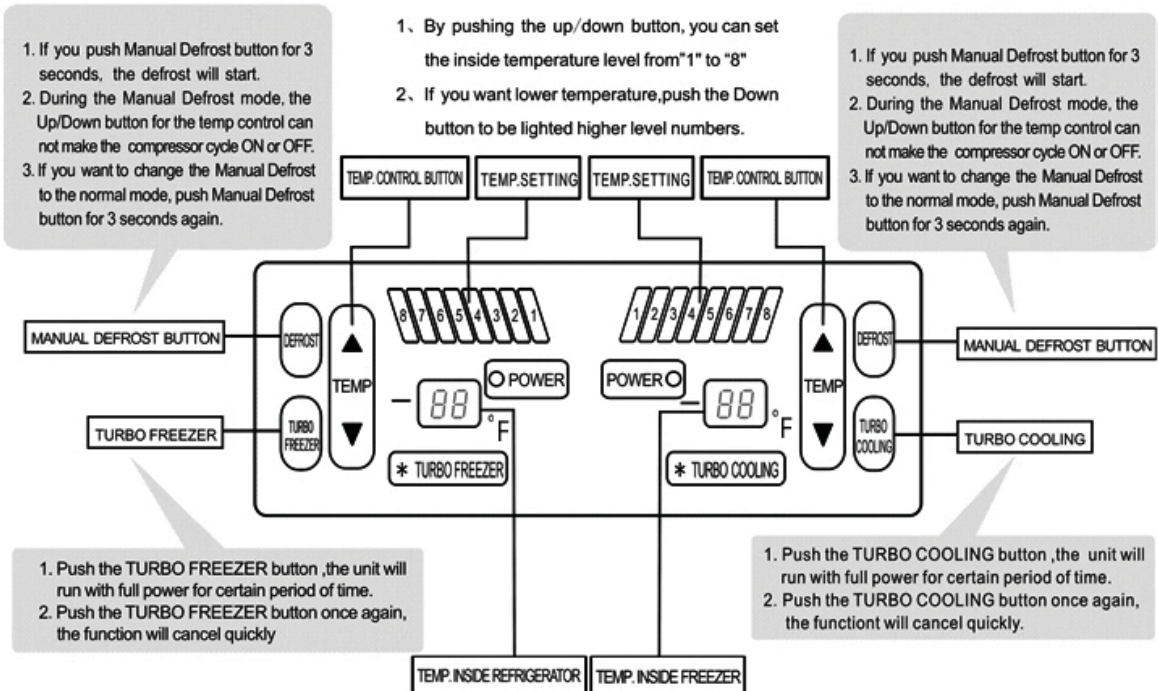

1. It displays inside temperature.
2. When the inside temperature is lower than  $-49^{\circ}\text{F}$  the panel will display 'LO'.

LO

and higher than  $+64.4^{\circ}\text{F}$ , the panel will display 'HI'.

HI

# PART NAME AND FUNCTION

## SALAD/UNDERCOUNTER

### 1. THE STRUCTURE OF SALAD

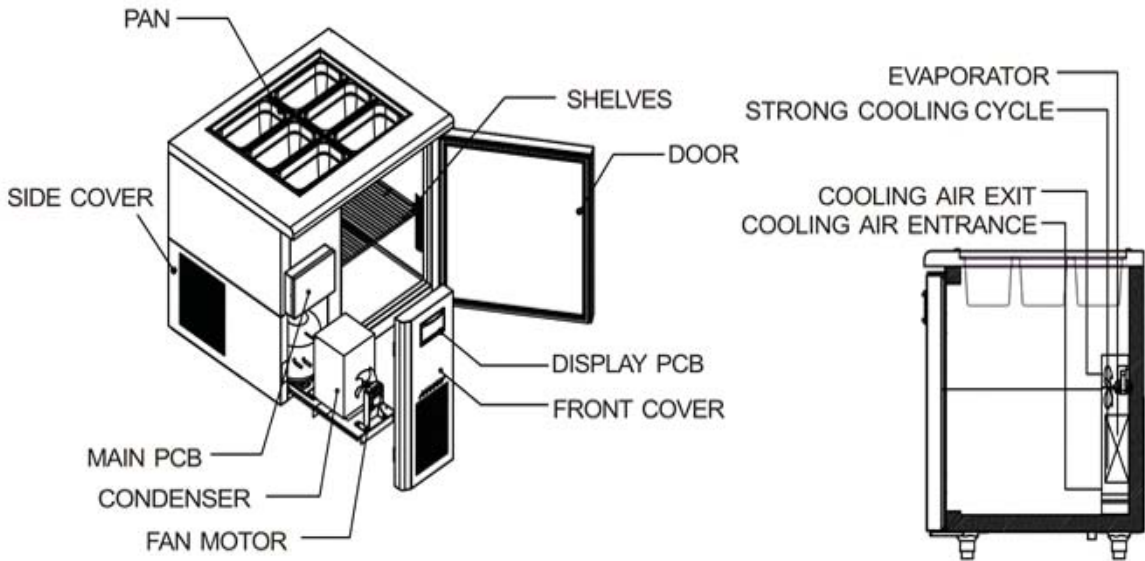

### 2. THE STRUCTURE OF UNDERCOUNTER

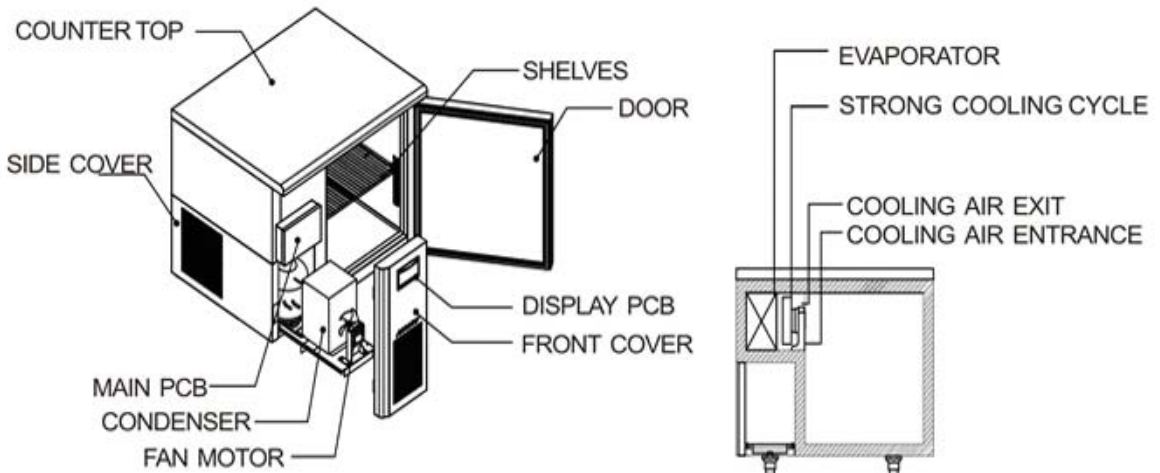

# DISPLAY PANEL OF REFRIGERATOR

## BASIC OPERATION

1. Plug in and turn on the power switch located on the top side of the unit front cover.  
The Display panel will be lighted and make a beep sound. The compressor will begin to run.
2. The default temperature setting is No. "4".
3. The compressor is automatically cycled by the electronic controller(PCB).
4. The Defrost cycle is automatically controlled by the PCB.
5. Set level toward "1" for higher temperature and "8" for lower temperatures.
6. Good Air Flow in refrigerator unit is critical.  
Be careful to load product so that it neither presses against the back wall, nor reaches within four inches from the evaporator compartment.

1. By pushing the up/down button, you can set the inside temperature level from "1" to "8"
2. If you want lower temperature, push the Down button to be lighted higher level numbers.

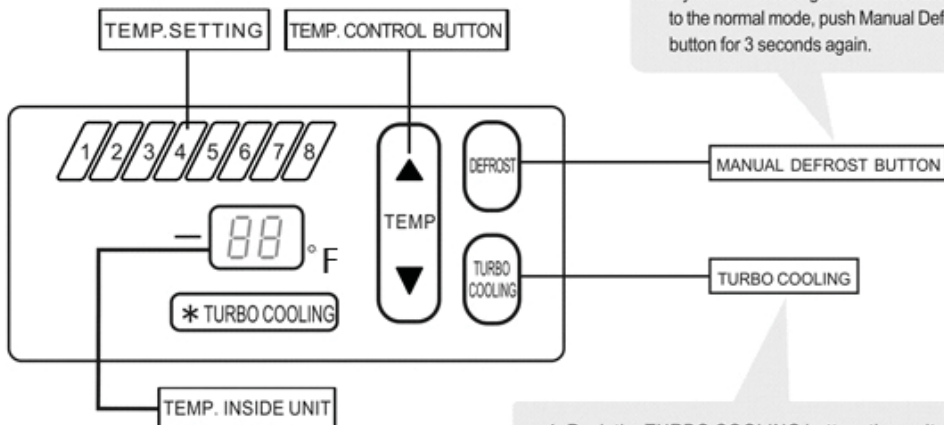

1. If you push Manual Defrost button for 3 seconds, the defrost will start.
2. During the Manual Defrost mode, the Up/Down button for the temp control can not make the compressor cycle ON or OFF.
3. If you want to change the Manual Defrost to the normal mode, push Manual Defrost button for 3 seconds again.

1. Push the TURBO COOLING button, the unit will run with full power for certain period of time.
2. Push the TURBO COOLING button once again, the function will cancel quickly.

1. It displays inside temperature.
2. When the inside temperature is lower than  $-49^{\circ}\text{F}$  the panel will display 'LO'.

LO

and higher than  $+64.4^{\circ}\text{C}$ , the panel will display 'HI'.

HI

## DISPLAY PANEL OF FREEZER

### BASIC OPERATION

1. Plug in and turn on the power switch located on the top side of the unit front cover.  
The Display panel will be lighted and make a beep sound. The compressor will begin to run.
2. The default temperature setting is No. "4".
3. The compressor is automatically cycled by the electronic controller(PCB).
4. The Defrost cycle is automatically controlled by the PCB.
5. Set level toward "1" for higher temperature and "8" for lower temperatures.
6. Good Air Flow in freezer unit is critical.

Be careful to load product so that it neither presses against the back wall, nor reaches within four inches from the evaporator compartment.

1. By pushing the up/down button, you can set the inside temperature level from "1" to "8"
2. If you want lower temperature, push the Down button to be lighted higher level numbers.

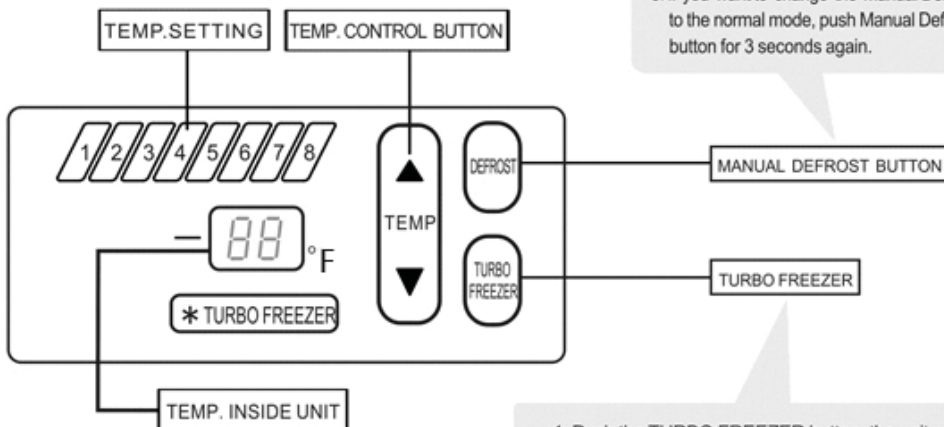

1. If you push Manual Defrost button for 3 seconds, the defrost will start.
2. During the Manual Defrost mode, the Up/Down button for the temp control can not make the compressor cycle ON or OFF.
3. If you want to change the Manual Defrost to the normal mode, push Manual Defrost button for 3 seconds again.

1. Push the TURBO FREEZER button, the unit will run with full power for certain period of time.
2. Push the TURBO FREEZER button once again, the function will cancel quickly

1. It displays inside temperature.
2. When the inside temperature is lower than  $-49^{\circ}\text{F}$  the panel will display 'LO'.







LO

and higher than  $+66.4^{\circ}\text{F}$ , the panel will display 'HI'.

HI

# CAUTION

## MARK AND NOTE

 <p><b>WARNING</b> It is dangerous for people</p>	 <p><b>PROHIBITION</b></p>
	 <p><b>NO SCREW</b></p>
 <p><b>CAUTION</b> It will cause injury to human or lost of property</p>	 <p><b>NO TOUCH</b></p>
	 <p><b>OBEY</b></p>
	 <p><b>PLUG OFF</b></p>



Be sure not to put more plug in the socket.

- Overheated wire will cause fire!

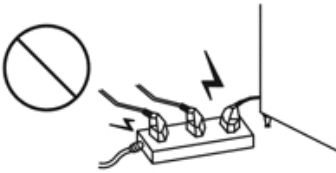

Please use a dedicated socket!



Wet hands off the power.

- Life is in danger



Be sure not to spray flammable aerosol around the product!

- Explosion, Fire etc.



Be sure not to allow children to enter the product!

- Life is in danger!



Please do not water product!

- Fire, electric shock etc.





# CAUTION



Do not put bottled drinks in the refrigerator for a long time

- Frost crack

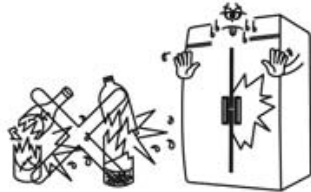

Please do not disassemble, repair or alter products!

- fire, electric shock etc



Be sure not touch the power When the gas leak!

- Leave the scene quickly after opening the windows

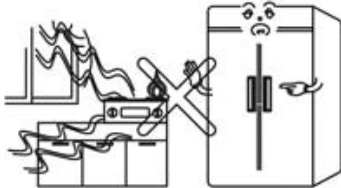

Disassemble all the switch gear before scrap!

- It hides danger when the children play in the unit!

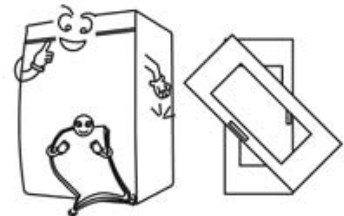

Please do not damage the power cord!

- Fire, electric shock etc.

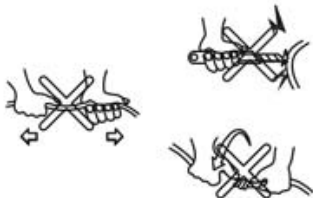

Please do not squeeze the power so that it is damaged !

- Fire, electric shock etc

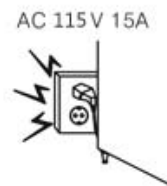

Be sure not to use abrasive cleaner!

- It will scratch the surface of product!

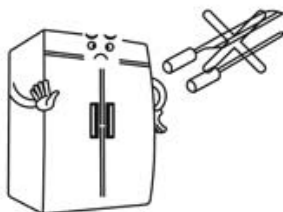

Be sure to avoid any partition and object which may stop air flow!



(GOOD) (NOT GOOD)

# CAUTION



Please choose the environment without rat to set the product

- Damage the power that will cause fire!

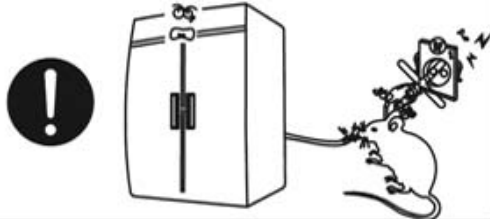

When the abnormal situation occurs, unplug the power then contact the nearest service center.

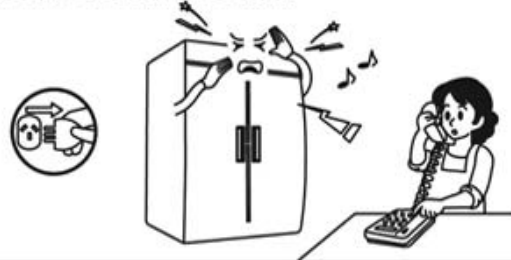

Do plug the power without dragging!

- Wire breakage

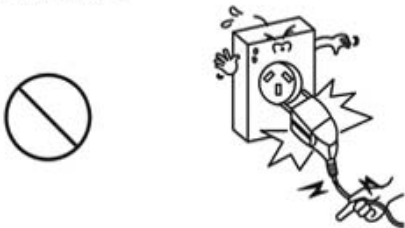

Please ask more people to carry the unit!

- No tilt!

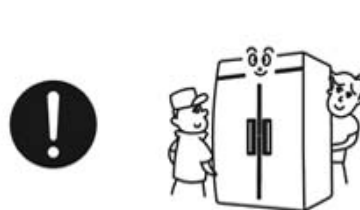

Be sure not to disassemble or replace the power which is damaged!

- Please contact the after sale service or ask a professional repairman in time



No objects on top of unit!

- Electric shock, fire, explosion etc.

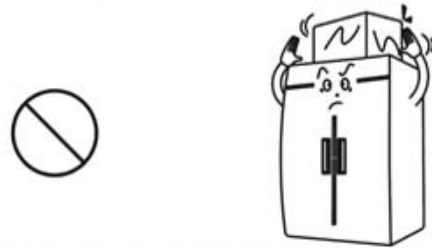

Do hold the door handle to open or close the door!

- It may cause injury when operator hold other parts!

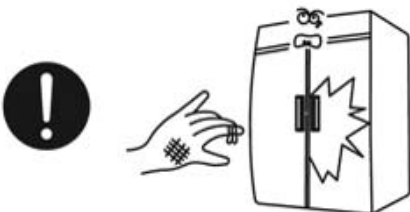

Be sure not to put too many objects in the refrigerator!

- The objects will fall to hit the operator with opening the door!



# CAUTION



Be sure not to put pharmaceuticals and chemicals!

- It will result in an explosion!



Be sure to avoid the children touching the unit!

- It is dangerous!

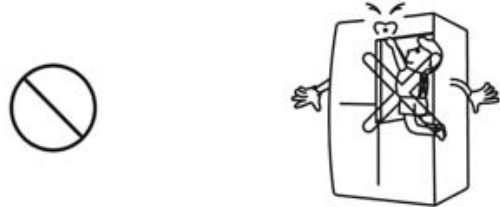

Please keep the plug clean!

- The dust and water will cause short circuit!



Be sure not to put hot food in the unit!

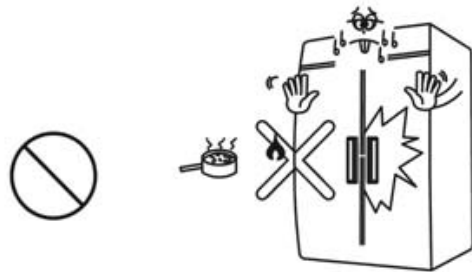

Please use the leakage protector to prevent the short circuit!

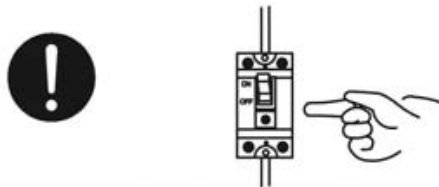

Be sure not to plug in the loose socket!

- Electric shock, fire etc.



Not touch the top and bottom of unit!

- It will cause injury!



Be sure not to store volatiles and combustibles!

- It is dangerous!



# INSTALLATION AND OPERATION

## ■ INSTALLATION NOTE

Be sure to set the unit in door!

- To prevent damage, leakage!

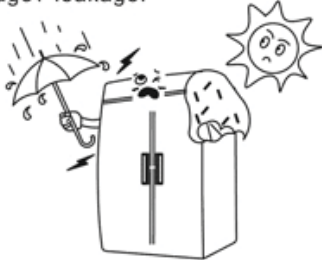

Be sure that the location be chosen has a strong enough floor to support total weight of the cabinet and any other contents.

- The uneven will make noise and shake!

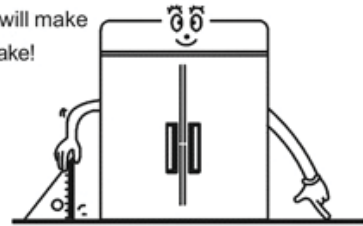

Be sure to avoid corrosive environment!

- It will shorten the life of the unit!

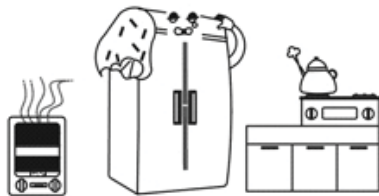

Be sure no objects is on top of the product!

- The objects will fall to hit the unit!

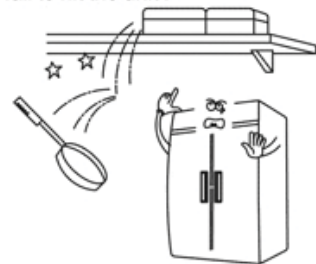

Be sure to avoid damp and dusty environment!

- Electric shock



Be sure the unit is away from the wall at least 15cm!

- Good air circulation

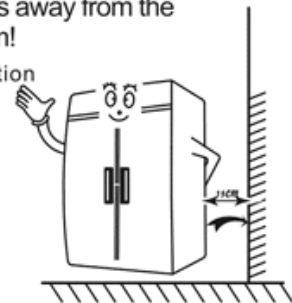

Be sure the power cord is connected to the proper voltage!

- The product is special for 110V
- It can't be used with the voltage of 220V
- Please connect the power with leakage protector!

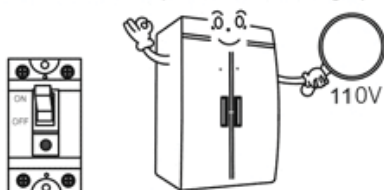

Please use the casters or legs.

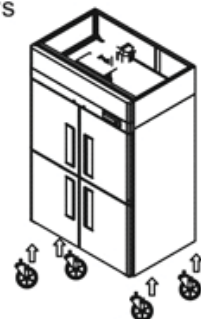

## INSTALLATION AND OPERATION

### CLEANING unplug the refrigerator

- To maintain proper refrigerator performance, the Condenser coil must be free of dust, dirt, and grease.
- This will require periodic cleaning. Condenser fins should be cleaned at least every three months(90days) or needed.

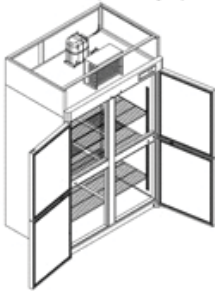

#### CLEANING THE INTERIOR AND EXTERIOR

- Please clean the product with a soft damp cloth! When the product is too dirty ,please use the cloth with a little of neutral detergent!
- Pull out the shelves to clean!
- Be sure not to use thinner, oil, water, iron brush, abrading agent, hydrochloric acid and other things to clean



#### CLEAN THE GASKET

- Much grease, food wastes etc will destroy the surface of gasket, especially the bottom side!
- Please use the cloth with neutral detergent to wipe the gasket.

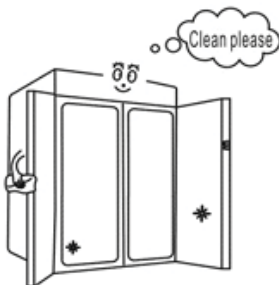

#### CHECK AFTER CLEANING

- Check the unit again for safety
- Check that the unit is operating properly.
- Make sure both power and plug are normal.
- Please read the operation manual carefully before operating the product.
- Please make sure the product is well sealed.
- Please place the product for a while to make it dry before use.

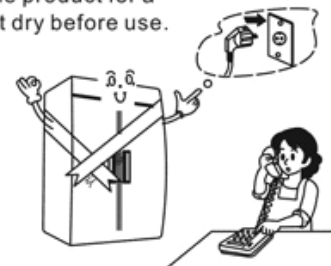

### PRECAUTIONS

#### THE UNIT WITHOUT USE FOR A LONG TIME

- Please empty the refrigerator then unplug it.
- Please lock the door to prevent the man from entering the unit.

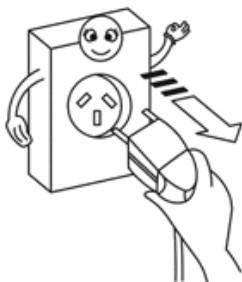

#### TRANSIT OR MOVE

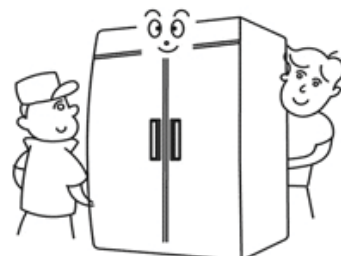

- Please unplug the refrigerator before transit or move
- Please ask more people to work when the product is heavier.
- Please reread the manual after moving then use the unit.



## INSTALLATION AND OPERATION

### ■ BEFORE REQUESTING SERVICE

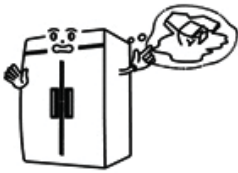
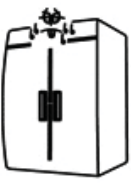
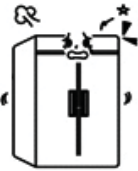
If the product is abnormal in the course of use, check it as follows, if you can not solve the problem, please contact the after sale service, and provide product information(such as model,serial number etc.)

	SYMPTOMS	CHECK AND SOLUTIONS
	1. The unit does not refrigerate at all	<ul style="list-style-type: none"> <li>▪ Check that the power cord and plug in correctly.</li> <li>▪ Be sure the power cord is connected to the proper voltage.</li> <li>▪ Be sure the power switch is turned on.</li> </ul>
	2. The unit does not refrigerate well.	<ul style="list-style-type: none"> <li>▪ Be sure the temp setting is on the correct position.</li> <li>▪ Check the partition of stored food.</li> <li>▪ The unit door is opened too frequently or left open too long</li> <li>▪ Be sure the unit is away from heater.</li> <li>▪ The condenser isn't clean for a long time.</li> </ul>
	3. There is loud noise.	<ul style="list-style-type: none"> <li>▪ The floor is uneven or the caster isn't set correctly.</li> <li>▪ Be sure the unit is away from any other objects.</li> <li>▪ Be sure nothing fall into the condensing unit.</li> </ul>
	4. There is peculiar smell.	<ul style="list-style-type: none"> <li>▪ The smelled food isn't completely covered.</li> <li>▪ Be sure the food is under guarantee.</li> <li>▪ The unit isn't clean for a long time.</li> </ul>

## TWO YEAR WARRANTY

Turbo air warrants to the original purchaser of every new Turbo air refrigerated unit, the cabinet and all parts thereof, to be free from defects in material or workmanship, under normal use and service, for a period of two (2) year from the date of original installation or 27 months after shipment date from Turbo air , whichever occurs first.

Any parts covered by this warranty that are examined and determined by Turbo air to have been defective within two (2) year of original installation or twenty seven (27) months after shipment date from manufacturer, whichever occurs first, shall be repaired or replaced as stated below. Turbo air shall be deemed to have fully complied with its obligation under the foregoing warranties by electing either one of the following procedures, at the sole discretion of Turbo air.

1. Furnishing a replacement part, freight collect, in even exchange for the returned part, freight collect.
2. Receiving the defective part, freight collect; repairing it; and returning it, freight collect.

## ADDITIONAL THREE YEAR COMPRESSOR WARRANTY

In addition to the (2) two year warranty stated above, Turbo air warrants its hermetically and semi-hermetically sealed compressor to be free from defects in both material and workmanship under normal use and service for a period of three (3) additional years from the date of original installation but not to exceed five (5) years and three (3) months after shipment from manufacturer.

Compressors determined by Turbo air have been defective within this extended time period will, at Turbo air's option, be either repaired or replaced with a compressor or compressor parts of similar design and capacity.

The three (3) year extended compressor warranty applies only to hermetically and semi-hermetically sealed parts of the compressor and does not apply to any other parts or components, including, but not limited to, cabinet, paint finish, temperature control, refrigerant, metering device, driers, motor starting equipment, fan assembly any other electrical component, etcetera.

## 134A(404A) COMPRESSOR WARRANTY

The five year compressor warranty detailed above will be voided if the following procedure is not carefully adhered to:

1. This system contains R134A refrigerant and polyol ester lubricant. The Polyol ester lubricant has rapid moisture absorbing qualities. If long exposure to the ambient conditions occur, the lubricant must be removed and replaced with new. Listed below are the approved lubricants for the Tecumseh compressors.

- 1 ICI-Emkarate RL 184
- 2 Emery-2927-A
- 3 Mobile Artic 22A

Failure to comply with recommended lubricant specification will void the compressor warranty.

2. Dryer replacement is very important and must be changed when a system is opened for servicing. dryer must be used with XH-9 desiccant.
3. Micron level vacuums must be achieved to insure low moisture levels in the system. 500 microns or lower must obtained.

## What is NOT covered by this warranty

Turbo air's sole obligation under this warranty is limited to either repair or replacement of parts, subject to the additional limitations below. This warranty neither assumes nor authorizes any person to assume obligations other than expressly covered by this warranty.

1. **WARRANTY IS NOT TRANSFERABLE.** This warranty is not assignable and applies only in favor of the original purchaser/user to whom delivered. ANY SUCH ASSIGNMENT OR TRANSFER SHALL VOID THE WARRANTIES HEREIN MADE AND SHALL VOID ALL WARRANTIES, EXPRESS OR IMPLIED, INCLUDING ANY WARRANTY OF MERCHANTABILITY OR FITNESS FOR A PARTICULAR PURPOSE.
2. **NO CONSEQUENTIAL DAMAGES.** TURBO AIR IS NOT RESPONSIBLE FOR ECONOMIC LOSS; PROFIT LOSS OR SPECIAL, INDIRECT, OR CONSEQUENTIAL DAMAGES, INCLUDING WITHOUT LIMITATION, LOSSES OR DAMAGES ARISING FROM FOOD OR PRODUCT SPOILAGE CLAIMS WHETHER OR NOT ON ACCOUNT OF REFRIGERATION FAILURE.
3. **ALTERATION, NEGLIGENCE, ABUSE, MISUSE, ACCIDENT, DAMAGE DURING TRANSIT OR INSTALLATION, FIRE, FLOOD, ACTS OF GOD.** TURBO AIR is not responsible for the repair or replacement of any parts that Turbo Air determines have been subjected after the date of manufacture to alteration, neglect, abuse, misuse, accident, damage during transit or installation, fire, flood, or an Act of God.
4. **NO IMPLIED WARRANTY OF MERCHANTABILITY OR FITNESS FOR A PARTICULAR PURPOSE.** THERE ARE NO OTHER WARRANTIES, EXPRESS, IMPLIED OR STATUTORY, EXCEPT THE TWO(2) YEAR WARRANTY AND THE ADDITIONAL THREE (3) YEAR COMPRESSOR WARRANTY AS DESCRIBED ABOVE. THESE WARRANTIES ARE EXCLUSIVE AND IN LIEU OF ALL OTHER WARRANTIES, INCLUDING IMPLIED WARRANTY AND MERCHANTABILITY OR FITNESS FOR A PARTICULAR PURPOSE. THERE ARE NO WARRANTIES WHICH EXTEND BEYOND THE DESCRIPTION ON THE FACE HEREOF.
5. **TRANSPORTATION COSTS.** Turbo Air will accept parts covered under this warranty freight collect, provided that shipment has received prior approval. Turbo Air is not responsible for any other transportation costs, but will ship freight collect parts either repaired or replaced under these warranties.
6. **WARRANTY CLAIMS.** All claims should include: model number of the cooler, the serial number of the cabinet, proof of purchase, date of installation, and all pertinent information supporting the existence of the alleged defect. Any action or breach of these warranty provisions must be commenced within two (2) year after that cause of action has accrued.

---

**Turbo air** REFRIGERATOR MANUFACTURER

1250 VICTORIA STREET  
CARSON, CA 90746  
TEL: 310-900-1000  
FAX: 310-900-1077  
TOLL FREE: 1-800-627-0032  
(U.S.A. & Canada)  
<http://www.turboairinc.com>



### **Warranty Claims...**

All claims for parts or labor must be made directly through Turbo Air.

All claims should include: model number of the unit, the serial number of the cabinet, proof of purchase, date of installation, and all pertinent information supporting the alleged defect.

In case of compressor replacement under warranty, either compressor or compressor tag must be returned to Turbo Air along with above listed information.

Failure to comply with warranty policies will result in voiding claims.

### **Two Year Parts & Labor Warranty...**

Turbo Air warrants all new refrigerated components, the cabinet and all parts, to be free from defects in materials or workmanship, under normal and proper use and maintenance service as specified by Turbo Air and upon proper installation and start-up in accordance with the instruction packet supplied with each Turbo air unit. Turbo Air's obligation under this warranty is limited to a period of two (2) year from the date of original installation or 27 months after shipment date from Turbo Air, whichever occurs first.

Any part, covered under this warranty, that are by Turbo Air to have been defective within two (2) year of original installation or twenty seven (27) months after shipment date from manufacturer, whichever occurs first, is limited to the repair or replacement, including labor charges, of defective parts or assemblies. The labor warranty shall include standard straight time labor charges only and reasonable travel time, as determined by Turbo Air.

### **Additional Three Year Compressor Warranty...**

In addition to the two (2) year warranty stated above, Turbo Air warrants its hermetically sealed compressor to be free from defects in both material and workmanship under normal and proper use and maintenance service for a period of three (3) additional years from the date of original installation, but not to exceed five (5) years and three(3) months after shipment from the manufacturer.

Compressor determined by Turbo Air to have been defective within this extended period will, at Turbo Air's discretion, be either repaired or replaced with a compressor or compressor parts of similar design and capacity.

The three (3) year extended compressor warranty applies only to hermetically sealed parts of the compressor and does not apply to any other parts or components, including, but not limited to, cabinet, paint finish, temperature control, refrigerant, metering device, driers, motor starting equipment, fan assembly or and other electrical components, etcetera.

### **404A / 134a Compressor Warranty...**

The five-year compressor warranty detailed above will be void if the following procedure is not carefully adhered to:

1. This system contains R404A or R134a refrigerant and polyol ester lubricant. The polyol ester lubricant has rapid moisture absorbing qualities.
2. Drier replacement is very important and must be changed when a system is opened for servicing. A620 copper drier or better is highly recommended.
3. Micron level vacuums must be achieved to insure low moisture levels in the system. 500 microns or lower must be obtained.
4. When compressor is grounded, suction drier and 620 drier or better must be replaced.
5. Compressor must be obtained through Turbo Air, unless otherwise specified in writing, through Turbo Air's warranty department.

### **404A / 134a Compressor Warranty...**

Turbo Air's sole obligation under this warranty is limited to either repair or replacement of parts, subject to the additional limitations below. This warranty neither assumes nor authorizes any person to assume obligations other than those expressly covered by this warranty.

NO CONSEQUENTIAL DAMAGES. TURBO AIR IS NOT RESPONSIBLE FOR ECONOMIC LOSS; PROFIT LOSS; OR SPECIAL, INDIRECT, OR CONSEQUENTIAL DAMAGES, INCLUDING WITHOUT LIMITATION, LOSSES, OR DAMAGES ARISING FROM FOOD OR PRODUCT SPOILAGE REGARDLESS OF WHETHER OR NOT THEY RESULT FROM REFRIGERATION FAILURE.

WARRANTY IS NOT TRANSFERABLE, This warranty is not assignable and applies only in favor of the original purchaser/user to whom delivered. ANY SUCH ASSIGNMENT OR TRANSFER SHALL VOID THE WARRANTIES HEREIN AND SHALL VOID ALL WARRANTIES, EXPRESS OR IMPLIED, INCLUDING ANY WARRANTY OF MERCHANTABILITY OR LABOR COVERAGE FOR COMPONENT FAILURE OR OTHER THE WARRANTY PACKET PROVIDED WITH THE UNIT.

ALTERATION, NEGLIGENCE, ABUSE, MISUSE, ACCIDENT, DAMAGE DURING TRANSIT OR INSTALLATION, FIRE, FLOOD, ACTS OF GOD. Turbo Air is not responsible for the repair or replacement of any parts that Turbo Air determines have been subjected after the date of manufacture to alteration, neglect, abuse, misuse, accident, damage during transit or installation, fire, flood, or act of GOD.

IMPROPER ELECTRICAL CONNECTIONS. TURBO AIR IS NOT RESPONSIBLE FOR THE REPAIR OR REPLACEMENT OF FAILED OR DAMAGED COMPONENTS RESULTING FROM ELECTRICAL POWER FAILURE, THE USE OF EXTENSION CORDS, LOW VOLTAGE, OR VOLTAGE DROPS TO THE UNIT. NO IMPLIED WARRANTY OF MERCHANTABILITY OR FITNESS FOR A PARTICULAR PURPOSE; THERE ARE NO OTHER WARRANTIES, EXPRESSED, IMPLIED OR STATUTORY, EXCEPT THE TWO (2) YEAR PARTS & LABOR WARRANTY AND THE ADDITIONAL THREE (3) YEAR COMPRESSOR WARRANTY AS DESCRIBED ABOVE. THESE WARRANTIES ARE EXCLUSIVE AND IN LIEU OF ALL OTHER WARRANTIES, INCLUDING IMPLIED WARRANTY AND MERCHANTABILITY OR FITNESS FOR A PARTICULAR PURPOSE. THERE ARE NO WARRANTIES, WHICH EXTEND BEYOND THE DESCRIPTION ON THE FACE HEREOF.

Outside U.S. and Canada; This warranty does not apply to, and Turbo Air is not responsible for, any warranty claims made on products sold or used outside the continent of the United States and Canada.