

CAUTION!
 PLEASE KEEP POWER
 SWITCH ON BEFORE
 OPERATING THIS EQUIPMENT

Glass Door Merchandiser Installation and Operation Manual

Please read this manual completely before attempting to install or operate this equipment!

FEATURE CHART

TGM-22RV

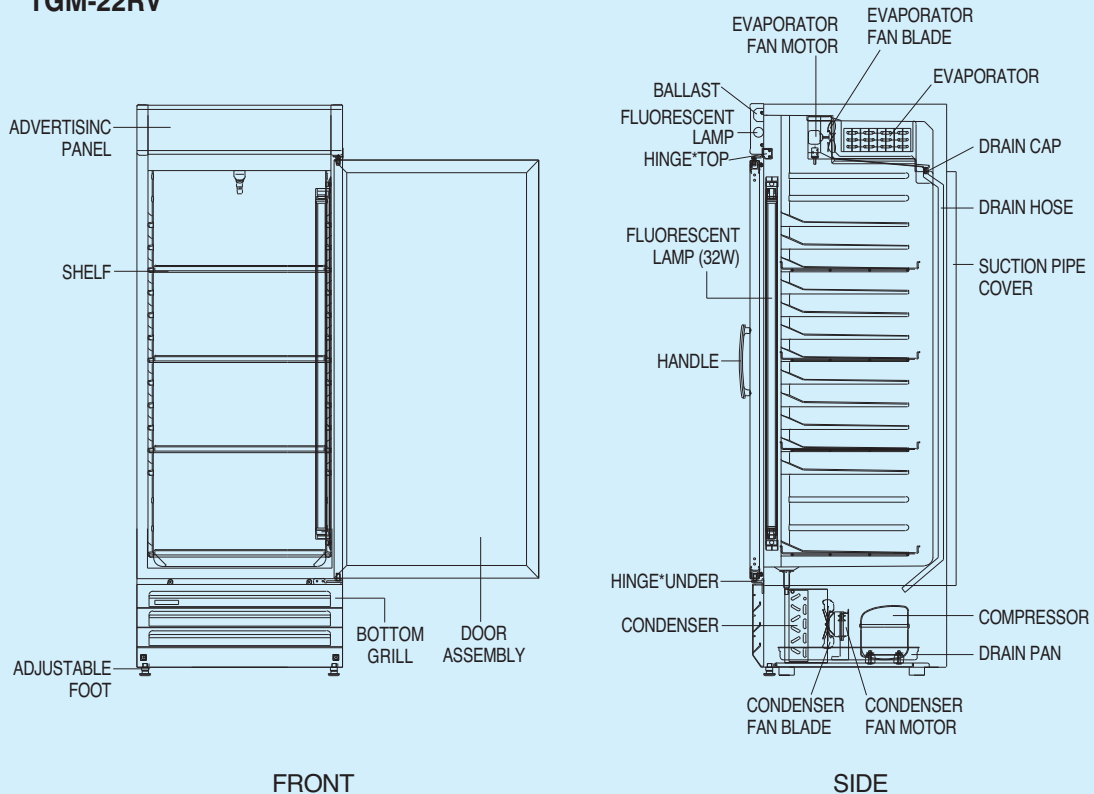

Castors are applied to TGM-22CRV model.
 How to install the castor and castor brake : Refer to page 3.
 Before operating this unit, please read these instructions completely.

HOW TO INSTALL

■ In good ventilation.

- Place the refrigerator in good ventilation for a good operation.

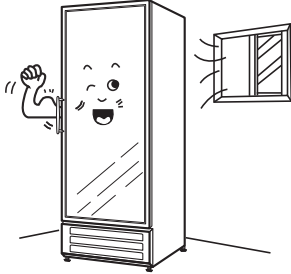

■ Place the refrigerator on hard and level floor.

- Unlevel floor may cause the refrigerator to make noise.

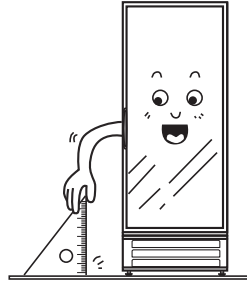

■ Put away heat source from the refrigerator.

- High ambient temperature will make cooling efficiency lower.

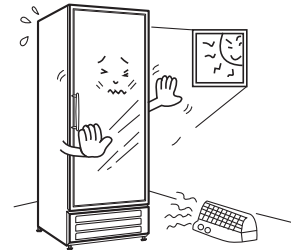

■ Install the refrigerator at indoor not to get wet from the rain.

- This unit is designed for indoor usage only.



■ Avoid places that are exposed to smoke.

- The discoloring can occur to the refrigerator.

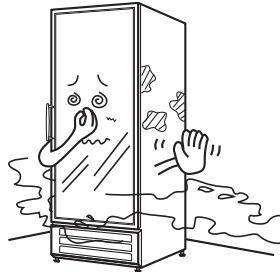

■ Place the refrigerator in an area with low moisture.

- Splashing water or a high moisture area may cause short circuit and make rusting easier.



■ Install the refrigerator on the places with 41~95°F.

- The stored materials could be frozen or broken at the degree below 41°F and cooling efficiency could be lower at the degree over 95°F.

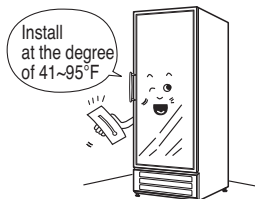

■ Set the front of the refrigerator a little bit higher than back-side by using adjustable feet to drain the water away easily.

Set the front side higher than back side.

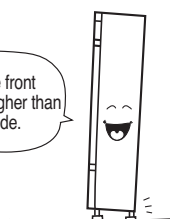

■ Adjust the temperature in the refrigerator.

- Temperature control is located on top right side. Set knob to normal position.

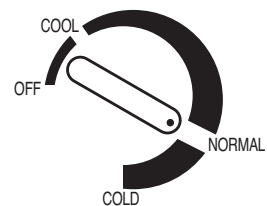

INSTALLATION OF CASTOR AND CASTOR BRAKE

- 1) Screw the castor (in rear side) and the castor brakes (in front side) by using castor wrench.
- 2) Use the castor shims to level the cabinet, if necessary, by inserting them to stems of the castors.

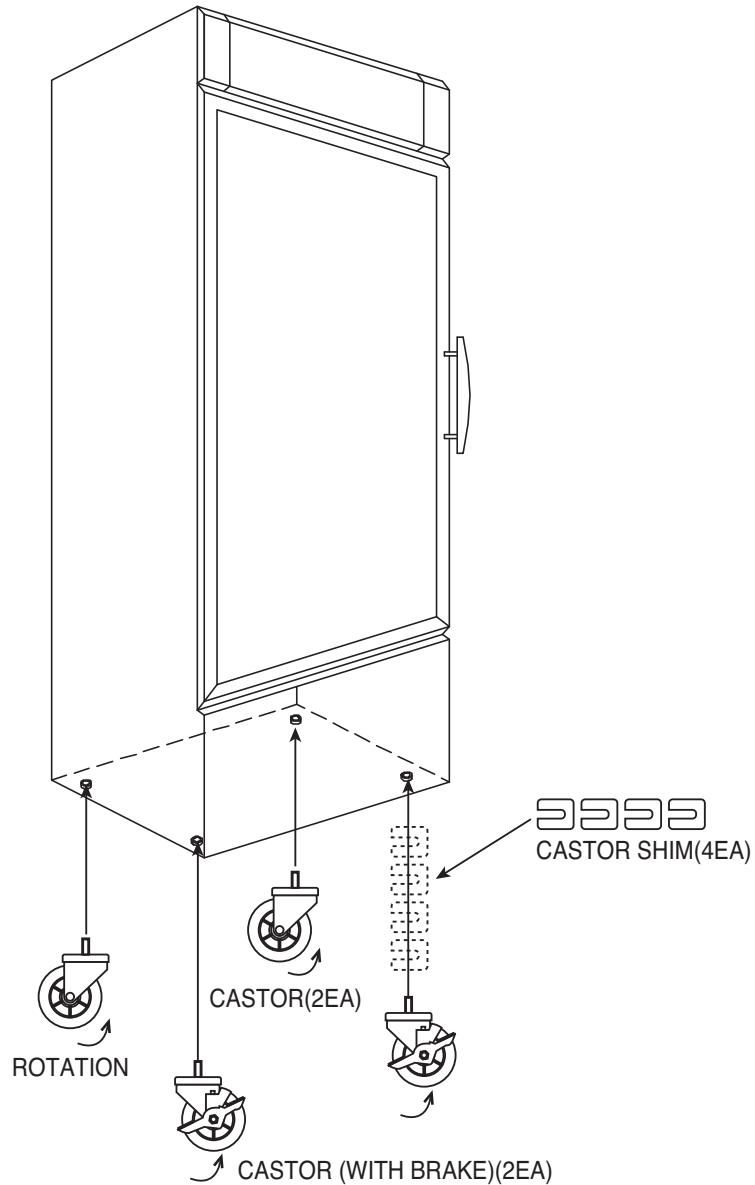

Model : TGM-22RV

CLEANING

■ Cleaning the interior and exterior

- Wash with warm soapy water and rinse with wet cloth.
- Wipe with dry cloth.
- Clean gasket frequently.
- Wash shelves with water.
- If unit has dew drops on exterior, wipe away with dry cloth. This tends to happen in the rainy season.

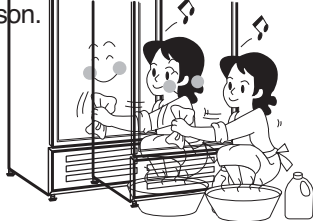

■ Check points after cleaning

- Check again the refrigerator for safety.
- Do not plug the power cord with wet hands.
- Check for noise or unit not getting cold.



■ Compressor

- A dirty condenser will not let unit cool efficiently. Clean the condenser every three months by using a brush or vacuum cleaner.
- Especially, be sure to clean the condenser before reoperating, after a long period of non-operation.

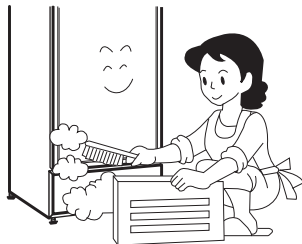

■ Caution

- Unplug the power cord before cleaning.
- Clean the refrigerator periodically.
- Do not use the abrasive cleaners, solvents or polishing agents on plastic parts. These cleansers may cause cracking or discoloring.

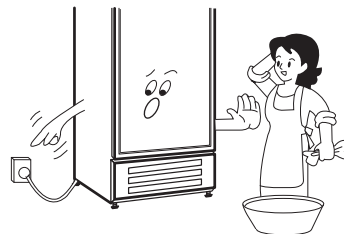

■ Drainage

- Take out the bottom grill to empty the tray.
- Clean it at least once in 2days.
(in rainy season, it needs everyday.)



CAUTION

■ Ventilation

- Place the unit in a well ventilated area.
- Keep the cabinet 4" from rear wall.

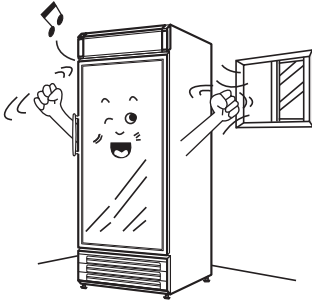

■ Warning

- Warranty will be voided if the following is found.
- Low voltage to unit. Should be 115V/60Hz.
- Power cord should not be more than 7 feet long from plug in connection to compressor.
- Multiple units plugged into same circuit.
- On extension cord.

■ Start-up

- Plug the power cord into the wall outlet.
- The outlet should be only for the refrigerator.
- The temperature controller should be on normal position.
- If disconnected, shut down, wait 5 minutes before re-starting it.

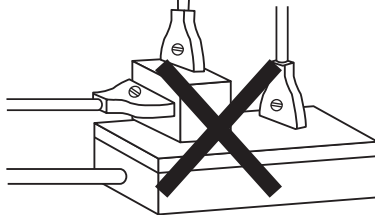

■ Temperature control

- To keep the temperature down : Turn the dial by CLOCK-WISE.
- To keep the temperature up : Turn the dial by COUNTER-CLOCK-WISE.

■ Before you operate the unit.

Please unscrew the Bottom grill and take out the pad in the Drain pan.

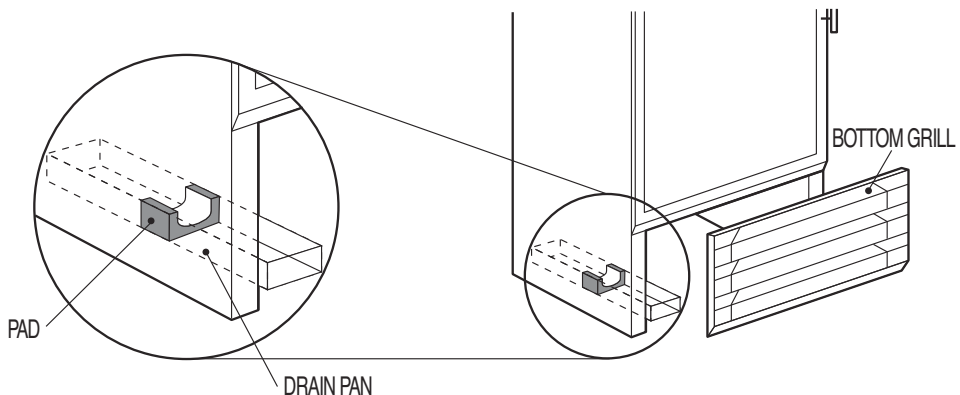

BEFORE REQUESTING SERVICE

SYMPTOMS	CAUSES	SOLUTIONS
Product freezing	• Only a small amount of product stored in unit.	• Turn temperature control to normal.
	• Product on top shelf only freezing.	• Rearrange product, due to close to fan.
	• Temperature of refrigerator below 35°F.	• Turn temperature control to normal.
Not working - compressor and light not on	• Power or electrical failure.	• Check power by plugging power cord into another outlet that has power.
Refrigerator not cooling well.	• When the refrigerator is in sunlight or near a unit that disperses heat.	• Remove from heat source.
	• When the refrigerator contains hot food or too much food.	• Remove hot food and allow to cool.
	• When the temperature control is not set correctly.	• Check position of temperature control.
	• When condenser coil is dirty.	• Clean condenser.
	• When refrigerator door is opened frequently or left open.	• Check the refrigerator door.
Noisy	<ul style="list-style-type: none"> • When the installation floor is weak or the adjustable feet is set incorrectly. • When the back-side of the refrigerator is close to the wall. • When the tray is not on the correct position. 	• Check the installation and insert the tray correctly.
Moisture on exterior of cabinet.	• High-moisture air can produce dewdrops during the rainy season.	• Wipe with dry cloth.
Moisture on interior of cabinet.	• When food with steam is stored.	• Wipe with dry cloth.
	• When door is opened frequently.	• Keep door closed as often as possible. Wipe with dry cloth.
Door does not close correctly.	• When door has slant.	• Adjust feet under cooler.
	• When floor is not level.	• Level unit.
	• When door gasket comes out of place.	• Reinsert gasket.

The following points are not malfunctions:

- Water-flowing sound can be heard when the compressor stops. This is a sound of REFRIGERANT flowing.
- When compressor stops by temperature control, it is not out of order.
- This is necessary so ice will not build up on evaporator.
- The door is warm to touch, due to heater that is installed.

HOW TO ADJUST A SHELF POSITION AND REPLACE A LAMP

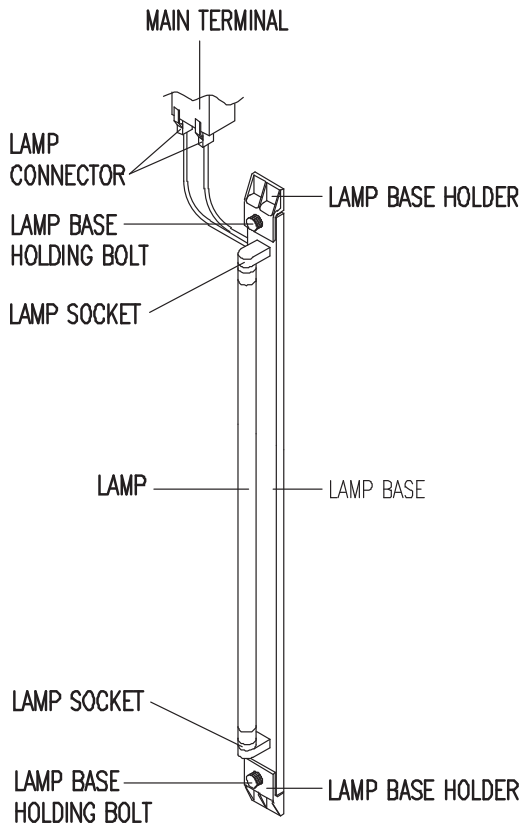

Please turn off the power before the positioning of shelves and installing a lamp.

– Care for electric shock.



Pull the lamp connector off the main terminal,
– Don't hold the wire but the connector housing while pulling it off.



Unscrew the lamp base holding bolt (2EA) from the lamp base.



Detach the lamp base holder from the lamp base.

★ After the work is done up to this stage
The shelves can be adjusted into new position.

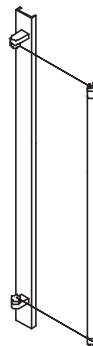

Separate the lamp from the lamp socket, and replace with the new lamp.

TWO YEAR WARRANTY

Turbo air warrants to the original purchaser of every new Turbo air refrigerated unit, the cabinet and all parts thereof, to be free from defects in material or workmanship, under normal use and service, for a period of two (2) year from the date of original installation or 27 months after shipment date from Turbo air , whichever occurs first.

Any parts covered by this warranty that are examined and determined by Turbo air to have been defective within two (2) year of original installation or twenty seven (27) months after shipment date from manufacturer, whichever occurs first, shall be repaired or replaced as stated below. Turbo air shall be deemed to have fully complied with its obligation under the foregoing warranties by electing either one of the following procedures, at the sole discretion of Turbo air.

1. Furnishing a replacement part, freight collect, in even exchange for the returned part, freight collect.
2. Receiving the defective part, freight collect; repairing it; and returning it, freight collect.

ADDITIONAL THREE YEAR COMPRESSOR WARRANTY

In addition to the (2) two year warranty stated above, Turbo air warrants its hermetically and semi-hermetically sealed compressor to be free from defects in both material and workmanship under normal use and service for a period of three (3) additional years from the date of original installation but not to exceed five (5) years and three (3) months after shipment from manufacturer.

Compressors determined by Turbo air have been defective within this extended time period will, at Turbo air's option, be either repaired or replaced with a compressor or compressor parts of similar design and capacity.

The three (3) year extended compressor warranty applies only to hermetically and semi-hermetically sealed parts of the compressor and does not apply to any other parts or components, including, but not limited to, cabinet, paint finish, temperature control, refrigerant, metering device, driers, motor starting equipment, fan assembly any other electrical component, etcetera.

134A(404A) COMPRESSOR WARRANTY

The five year compressor warranty detailed above will be voided if the following procedure is not carefully adhered to:

1. This system contains R134A refrigerant and polyol ester lubricant. The Polyol ester lubricant has rapid moisture absorbing qualities. If long exposure to the ambient conditions occur, the lubricant must be removed and replaced with new. Listed below are the approved lubricants for the Tecumseh compressors.

- 1 ICI-Emkarate RL 184
- 2 Emery-2927-A
- 3 Mobile Artic 22A

Failure to comply with recommended lubricant specification will void the compressor warranty.

2. Dryer replacement is very important and must be changed when a system is opened for servicing. dryer must be used with XH-9 desiccant.
3. Micron level vacuums must be achieved to insure low moisture levels in the system. 500 microns or lower must obtained.

What is NOT covered by this warranty

Turbo air's sole obligation under this warranty is limited to either repair or replacement of parts, subject to the additional limitations below. This warranty neither assumes nor authorizes any person to assume obligations other than expressly covered by this warranty.

1. **WARRANTY IS NOT TRANSFERABLE.** This warranty is not assignable and applies only in favor of the original purchaser/user to whom delivered. ANY SUCH ASSIGNMENT OR TRANSFER SHALL VOID THE WARRANTIES HEREIN MADE AND SHALL VOID ALL WARRANTIES, EXPRESS OR IMPLIED, INCLUDING ANY WARRANTY OF MERCHANTABILITY OR FITNESS FOR A PARTICULAR PURPOSE.
2. **NO CONSEQUENTIAL DAMAGES.** TURBO AIR IS NOT RESPONSIBLE FOR ECONOMIC LOSS; PROFIT LOSS OR SPECIAL, INDIRECT, OR CONSEQUENTIAL DAMAGES, INCLUDING WITHOUT LIMITATION, LOSSES OR DAMAGES ARISING FROM FOOD OR PRODUCT SPOILAGE CLAIMS WHETHER OR NOT ON ACCOUNT OF REFRIGERATION FAILURE.
3. **ALTERATION, NEGLIGENCE, ABUSE, MISUSE, ACCIDENT, DAMAGE DURING TRANSIT OR INSTALLATION, FIRE, FLOOD, ACTS OF GOD.** TURBO AIR is not responsible for the repair or replacement of any parts that Turbo Air determines have been subjected after the date of manufacture to alteration, neglect, abuse, misuse, accident, damage during transit or installation, fire, flood, or an Act of God.
4. **NO IMPLIED WARRANTY OF MERCHANTABILITY OR FITNESS FOR A PARTICULAR PURPOSE.** THERE ARE NO OTHER WARRANTIES, EXPRESS, IMPLIED OR STATUTORY, EXCEPT THE TWO(2) YEAR WARRANTY AND THE ADDITIONAL THREE (3) YEAR COMPRESSOR WARRANTY AS DESCRIBED ABOVE. THESE WARRANTIES ARE EXCLUSIVE AND IN LIEU OF ALL OTHER WARRANTIES, INCLUDING IMPLIED WARRANTY AND MERCHANTABILITY OR FITNESS FOR A PARTICULAR PURPOSE. THERE ARE NO WARRANTIES WHICH EXTEND BEYOND THE DESCRIPTION ON THE FACE HEREOF.
5. **TRANSPORTATION COSTS.** Turbo Air will accept parts covered under this warranty freight collect, provided that shipment has received prior approval. Turbo Air is not responsible for any other transportation costs, but will ship freight collect parts either repaired or replaced under these warranties.
6. **WARRANTY CLAIMS.** All claims should include: model number of the cooler, the serial number of the cabinet, proof of purchase, date of installation, and all pertinent information supporting the existence of the alleged defect. Any action or breach of these warranty provisions must be commenced within two (2) year after that cause of action has accrued.

Turbo air REFRIGERATOR MANUFACTURER

1250 VICTORIA STREET
CARSON, CA 90746
TEL: 310-900-1000
FAX: 310-900-1077
TOLL FREE: 1-800-627-0032
(U.S.A. & Canada)
<http://www.turboairinc.com>

Warranty Claims...

All claims for parts or labor must be made directly through Turbo Air.

All claims should include: model number of the unit, the serial number of the cabinet, proof of purchase, date of installation, and all pertinent information supporting the alleged defect.

In case of compressor replacement under warranty, either compressor or compressor tag must be returned to Turbo Air along with above listed information.

Failure to comply with warranty policies will result in voiding claims.

Two Year Parts & Labor Warranty...

Turbo Air warrants all new refrigerated components, the cabinet and all parts, to be free from defects in materials or workmanship, under normal and proper use and maintenance service as specified by Turbo Air and upon proper installation and start-up in accordance with the instruction packet supplied with each Turbo air unit. Turbo Air's obligation under this warranty is limited to a period of two (2) year from the date of original installation or 27 months after shipment date from Turbo Air, whichever occurs first.

Any part, covered under this warranty, that are by Turbo Air to have been defective within two (2) year of original installation or twenty seven (27) months after shipment date from manufacturer, whichever occurs first, is limited to the repair or replacement, including labor charges, of defective parts or assemblies. The labor warranty shall include standard straight time labor charges only and reasonable travel time, as determined by Turbo Air.

Additional Three Year Compressor Warranty...

In addition to the two (2) year warranty stated above, Turbo Air warrants its hermetically sealed compressor to be free from defects in both material and workmanship under normal and proper use and maintenance service for a period of three (3) additional years from the date of original installation, but not to exceed five (5) years and three(3) months after shipment from the manufacturer.

Compressor determined by Turbo Air to have been defective within this extended period will, at Turbo Air's discretion, be either repaired or replaced with a compressor or compressor parts of similar design and capacity.

The three (3) year extended compressor warranty applies only to hermetically sealed parts of the compressor and does not apply to any other parts or components, including, but not limited to, cabinet, paint finish, temperature control, refrigerant, metering device, driers, motor starting equipment, fan assembly or and other electrical components, etcetera.

404A / 134a Compressor Warranty...

The five-year compressor warranty detailed above will be void if the following procedure is not carefully adhered to:

1. This system contains R404A or R134a refrigerant and polyol ester lubricant. The polyol ester lubricant has rapid moisture absorbing qualities.
2. Drier replacement is very important and must be changed when a system is opened for servicing. A620 copper drier or better is highly recommended.
3. Micron level vacuums must be achieved to insure low moisture levels in the system. 500 microns or lower must be obtained.
4. When compressor is grounded, suction drier and 620 drier or better must be replaced.
5. Compressor must be obtained through Turbo Air, unless otherwise specified in writing, through Turbo Air's warranty department.

404A / 134a Compressor Warranty...

Turbo Air's sole obligation under this warranty is limited to either repair or replacement of parts, subject to the additional limitations below. This warranty neither assumes nor authorizes any person to assume obligations other than those expressly covered by this warranty.

NO CONSEQUENTIAL DAMAGES. TURBO AIR IS NOT RESPONSIBLE FOR ECONOMIC LOSS; PROFIT LOSS; OR SPECIAL, INDIRECT, OR CONSEQUENTIAL DAMAGES, INCLUDING WITHOUT LIMITATION, LOSSES, OR DAMAGES ARISING FROM FOOD OR PRODUCT SPOILAGE REGARDLESS OF WHETHER OR NOT THEY RESULT FROM REFRIGERATION FAILURE.

WARRANTY IS NOT TRANSFERABLE, This warranty is not assignable and applies only in favor of the original purchaser/user to whom delivered. ANY SUCH ASSIGNMENT OR TRANSFER SHALL VOID THE WARRANTIES HEREIN AND SHALL VOID ALL WARRANTIES, EXPRESS OR IMPLIED, INCLUDING ANY WARRANTY OF MERCHANTABILITY OR LABOR COVERAGE FOR COMPONENT FAILURE OR OTHER THE WARRANTY PACKET PROVIDED WITH THE UNIT.

ALTERATION, NEGLIGENCE, ABUSE, MISUSE, ACCIDENT, DAMAGE DURING TRANSIT OR INSTALLATION, FIRE, FLOOD, ACTS OF GOD. Turbo Air is not responsible for the repair or replacement of any parts that Turbo Air determines have been subjected after the date of manufacture to alteration, neglect, abuse, misuse, accident, damage during transit or installation, fire, flood, or act of GOD.

IMPROPER ELECTRICAL CONNECTIONS. TURBO AIR IS NOT RESPONSIBLE FOR THE REPAIR OR REPLACEMENT OF FAILED OR DAMAGED COMPONENTS RESULTING FROM ELECTRICAL POWER FAILURE, THE USE OF EXTENSION CORDS, LOW VOLTAGE, OR VOLTAGE DROPS TO THE UNIT. NO IMPLIED WARRANTY OF MERCHANTABILITY OR FITNESS FOR A PARTICULAR PURPOSE; THERE ARE NO OTHER WARRANTIES, EXPRESSED, IMPLIED OR STATUTORY, EXCEPT THE TWO (2) YEAR PARTS & LABOR WARRANTY AND THE ADDITIONAL THREE (3) YEAR COMPRESSOR WARRANTY AS DESCRIBED ABOVE. THESE WARRANTIES ARE EXCLUSIVE AND IN LIEU OF ALL OTHER WARRANTIES, INCLUDING IMPLIED WARRANTY AND MERCHANTABILITY OR FITNESS FOR A PARTICULAR PURPOSE. THERE ARE NO WARRANTIES, WHICH EXTEND BEYOND THE DESCRIPTION ON THE FACE HEREOF.

Outside U.S. and Canada; This warranty does not apply to, and Turbo Air is not responsible for, any warranty claims made on products sold or used outside the continent of the United States and Canada.