

Vertical Cutter Mixer



- All stainless steel machine.
- Adjustable 3-blade knife assembly gives equal results for small or large batches.
- Bowl is easily removed for cleaning.
- Bowl tilts for easy removal of product.
- Polycarbonate lid designed to allow the addition of liquids or ingredients during processing.
- Digital timer for better preparation control.
- Stainless steel bowl and frame designed to be simple to use and to clean.
- Delivered with 23 Qt. stainless steel bowl and 3 blade smooth knife assembly.
- 1 year parts and labor warranty.

23 quart bowl unit designed for vertical cutting and mixing: mix, chop, puree, blend, mix and knead doughs.



Robot Coupe U.S.A., Inc.

P.O. Box 16625

Jackson, MS 39236-6625

1-800-824-1646 • (601) 898-8411

FAX: (601) 898-9134

www.robotcoupeusa.com • e-mail: robocoup@misnet.com

SPECIFICATIONS ON REVERSE SIDE

Specifications

STANDARD PACK: R23 vertical cutter mixer, 1 stainless steel bowl of 23 qts. and smooth 3-blade assembly.

ELECTRICAL: 220V, 60 Hz, 30 Amp, three-phase.

MOTOR: 5 HP/ 6 HP, 1800 and 3600 rpm, three-phase

SAFETIES: Comply with electrical standard ETL, cETL, magnetic safety and thermal protection, bowl detection device, bowl detection in vertical position device, lid detection device and locking lid detection devices.

BOWL CAPACITY: 23 Quarts.

WEIGHT: 243 lbs.

OPTIONAL EQUIPMENT:

- 3 blade coarse serrated knife assembly
- 3 blade fine serrated knife assembly
- Lid wiper assembly
- Bowl wiper assembly

STANDARDS: ETL, ETL Sanitation, cETL.

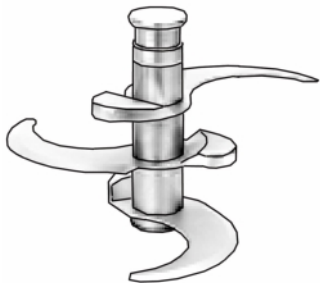

Three Blade Assembly

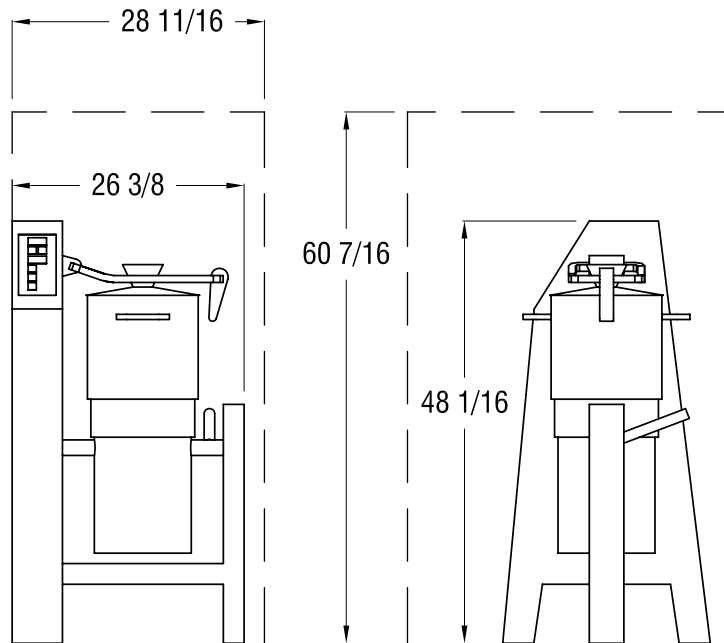
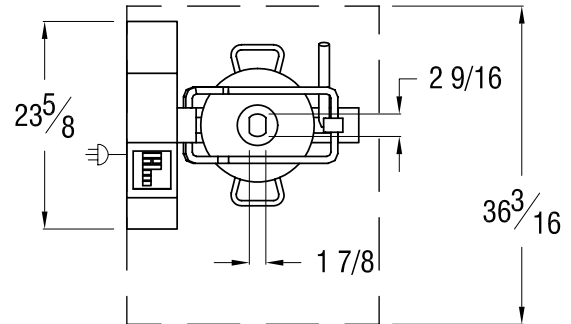

Robot Coupe U.S.A., Inc.

P.O. Box 16625

Jackson, MS 39236-6625

1-800-824-1646

(601) 898-8411

FAX: (601) 898-9134

www.robotcoupeusa.com

e-mail: robocoup@misnet.com

Distributed by: