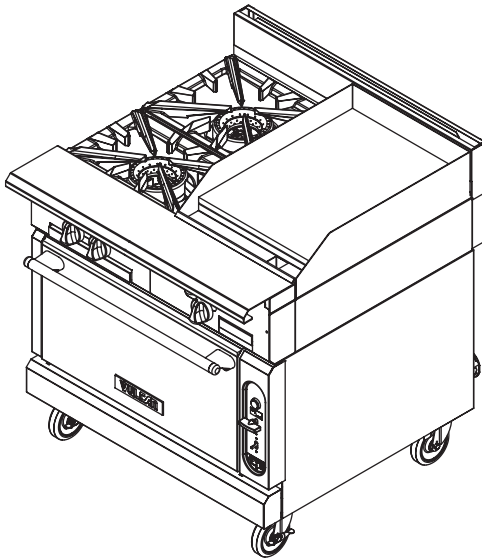

HEAVY DUTY COOKING**VULCAN****HEAVY DUTY GAS RANGE
2 BURNERS / 18" WIDE MANUAL GRIDDLE
36" WIDE GAS RANGE****Model V2BG18**

(shown on a convection oven base)

**SPECIFICATIONS**

36" wide heavy duty gas range, Vulcan Model No. V2BG18 (modular) and V2BG18B (cabinet base), V2BG18S (standard oven base) or V2BG18C (convection oven base). Modular construction for ease of installation. Stainless steel front, plate ledge, front top ledge with pull-out condiment rails, sides, base, stub back and 6" adjustable legs on all "B", "S", & "C" models. Stainless steel extra deep crumb tray. Two 33,000 BTU/hr. cast burners with lift-off burner heads and one 30,000 BTU/hr. griddle burner. Individual pilots and controls for each burner. Heavy duty cast burner grates, easy lift off 11" x 17" in front, 14" x 17" plates in rear. Grates and plates are separate from aeration bowl for ease of cleaning. 18" ground steel griddle plate. **Standard Oven:** 50,000 BTU/hr. with porcelain oven bottom, sides, and interior door panel. **Convection Oven:** 32,000 BTU/hr. with porcelain oven bottom, sides, and interior door panel (115v-1 phase blower motor, 4 amps, 9' cord & plug). Ovens measure 27"w x 27"d x 13"h. Standard oven thermostats adjust from 150° – 550°F. Convection oven adjusts from 175° – 550°F and the optional finishing oven for standard ovens adjusts from 300° – 650°F. Standard oven supplied with one rack, convection oven with two. Both ovens allow for three rack positions. Oven door is heavy duty with counter weight door hinges. 1¼" diameter front manifold and 1¼" rear gas connection, capped. Total input 60,000 BTU/hr.

Exterior Dimensions:

41⅞"d x 36"w x 40½"h on 6" adjustable legs

- V2BG18** 2-Burners / 18" Manual Griddle / Modular
- V2BG18B** 2-Burners / 18" Manual Griddle / Cabinet Base
- V2BG18S** 2-Burners / 18" Manual Griddle / Standard Oven
- V2BG18C** 2-Burners / 18" Manual Griddle / Convection Oven

STANDARD FEATURES

- Stainless steel front, front top ledge, burner box, sides, base and stub back
- 1¼" diameter front gas manifold with 1¼" rear gas connection (capped)
- 33,000 BTU/hr. open top burners with lift off heads
- 30,000 BTU/hr. griddle burners
- 50,000 BTU/hr. standard oven burner
- 32,000 BTU/hr. convection oven burner
- Porcelain oven cavity
- Individual pilots and controls for each burner
- Heavy-duty cast grates
- ¾" ground steel griddle plate
- 4" stainless steel stub riser
- 6" adjustable stainless steel legs for "S", "C", and "B" models
- Stainless steel cabinet base doors for "B" models
- Universal rack guides, one removable shelf (cabinet base)
- One year limited parts and labor warranty

OPTIONAL FEATURES (Factory Installed)

- Cap and cover front manifold
- Stainless steel oven cavity
- 650°F oven thermostat and steel hearth. ("S" models)
- Fan cooling package. ("C" models)
- 4" adjustable flanged feet for modular models
- Less legs for dolly mounting for "S", "C", and "B" models
- 3" high toe base for curb mounting

ACCESSORIES (Packaged & Sold Separately)

- ¾", 1", or 1¼" gas pressure regulator (specify gas type – pack loose)
- Set of 4 casters, 6" high (two locking)
- 6" adjustable flanged feet for "S", "C", and "B" models
- Extra removable shelves for use with Universal rack guides (for cabinet base)
- Banking strip
- Common condiment type, telescoping plate rails (starting at 24" length)
- 10", 22", or 34" high back risers (no shelf)
- 22" single deck solid or flo-thru high shelf risers
- 34" double deck solid or flo-thru high shelf risers
- Dolly frames
- Flexible gas hose with quick disconnect & restraining device

VULCAN

a division of ITW Food Equipment Group LLC

P.O. Box 696 ■ Louisville, KY 40201 ■ Toll-free: 1-800-814-2028 ■ Local: 502-778-2791 ■ Quote & Order Fax: 1-800-444-0602



HEAVY DUTY GAS RANGE
2 BURNERS / 18" WIDE MANUAL GRIDDLE
36" WIDE GAS RANGE

INSTALLATION INSTRUCTIONS

1. A properly sized gas pressure regulator suitable for battery or single unit application must be furnished and installed. Natural gas 6.0" W.C., propane gas 10.0" W.C.
 2. An adequate ventilation system is required for commercial cooking equipment. Information may be obtained by writing to the National Fire Protection Association, 1 Batterymarch Park, Quincy, MA 02269, www.NFPA.org. When writing, refer to NFPA No. 96.
 3. These units are manufactured for installation in accordance with ANSZ223.1A (latest edition), National Fuel Gas Code. Copies may be obtained from The American Gas Association, 400 N Capitol St. NW, Washington, DC 20001, www.AGA.org.
 4. **Clearances**

	Rear	Sides
Combustible	10"	10"
Non-combustible	0"	0"
 5. For proper combustion, install equipment on adjustable legs or casters. On curb or platform, allow 3½" front overhang. Toe base with leveling bolts are required for curb installation. Specify when ordering.
 6. Cannot be battered with GH series equipment.
 7. This appliance is manufactured for commercial installation only and is not intended for home use.
- NOTE:** In line with its policy to continually improve its product, Vulcan reserves the right to change materials and specifications without notice.

Specify type of gas when ordering.
Specify altitude when above 2,000 feet.

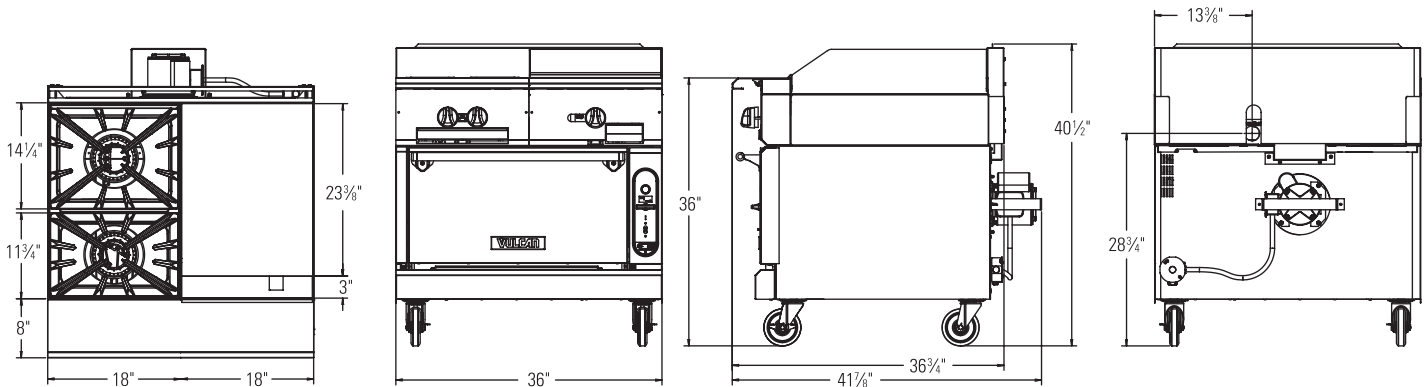

TOP CONFIGURATION	MODEL NUMBER	DESCRIPTION	TOTAL INPUT BTU / HR	SHIPPING WEIGHT LBS / KG
	V2BG18	2-Burners / 18" Wide Manual Griddle / Modular	96,000	332 / 151
	V2BG18B	2-Burners / 18" Wide Manual Griddle / Cabinet Base	96,000	432 / 196
	V2BG18S	2-Burners / 18" Wide Manual Griddle / Standard Oven	146,000	613 / 279
	V2BG18C	2-Burners / 18" Wide Manual Griddle / Convection Oven	128,000	691 / 314



a division of ITW Food Equipment Group LLC

P.O. Box 696 ■ Louisville, KY 40201 ■ Toll-free: 1-800-814-2028 ■ Local: 502-778-2791 ■ Quote & Order Fax: 1-800-444-0602

NOTE: In line with its policy to continually improve its products, Vulcan reserves the right to change materials and specifications without notice.